

UZ Series

Submersible Sewage & Wastewater Pumps

with Vortex Impeller

OPERATION MANUAL

INTRODUCTION

Thank you for selecting the Tsurumi UZ Submersible Sewage & Wastewater Pumps.

This equipment should not be used for applications other than those listed in this manual. Failure to observe this precaution may lead to a malfunction or an accident. In the event of a malfunction or an accident, the manufacturer will not assume any liability. After reading this Operation Manual, keep it in a location that is easily accessible, so that it can be referred to whenever information is needed while operating the equipment.

CONTENTS

1. BE SURE TO READ FOR SAFETY	1
2. PART NAMES.....	4
3. PRIOR TO OPERATION	4
4. INSTALLATION	5
5. ELECTRICAL WIRING	8
6. OPERATION.....	11
7. MAINTENANCE AND INSPECTION.....	14
8. DISASSEMBLY AND REASSEMBLY PROCEDURE	16
9. TROUBLESHOOTING	17

TSURUMI MANUFACTURING CO., LTD.

1 BE SURE TO READ FOR YOUR SAFETY

Be sure to thoroughly read and understand the SAFETY PRECAUTIONS given in this section before using the equipment in order to operate the equipment correctly.

The precautionary measures described in this section are intended to prevent danger or damage to you or to others. The contents of this manual that could possibly be performed improperly are classified into two categories: **⚠ WARNING**, and **⚠ CAUTION**. The categories indicate the extent of possible damage or the urgency of the precaution. Note however, that what is included under **⚠ CAUTION** may at times lead to a more serious problem. In either case, the categories pertain to safety-related items, and as such, must be observed carefully.

- **⚠ WARNING** : Operating the equipment improperly by failing to observe this precaution may possibly lead to death or injury to humans.
- **⚠ CAUTION** : Operating the equipment improperly by failing to observe this precaution may possibly cause injury to humans and other physical damage.
- **NOTE** : Gives information that does not fall in the WARNING or CAUTION categories.
- **Explanation of Symbols:**



The **△** mark indicates a WARNING or CAUTION item. The symbol inside the mark describes the precaution in more detail ("electrical shock", in the case of the example on the left).



The **⊘** mark indicates a prohibited action. The symbol inside the mark, or a notation in the vicinity of the mark describes the precaution in more detail ("disassembly prohibited", in the case of the example on the left).



The **●** mark indicates an action that must be taken, or instructs how to perform a task. The symbol inside the mark describes the precaution in more detail ("provide ground work", in the case of the example on the left).













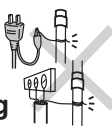

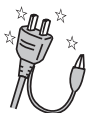

PRECAUTIONS TO THE PRODUCT SPECIFICATIONS

⚠ CAUTION	
	<ul style="list-style-type: none"> ● Do not operate the product under any conditions other than those for which it is specified. Failure to observe the precaution can lead to electrical leakage, electrical shock, fire, or water leakage, etc.





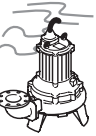

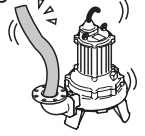





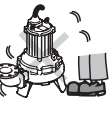

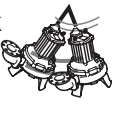





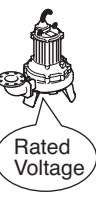

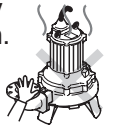



PRECAUTIONS DURING TRANSPORT AND INSTALLATION

⚠ WARNING	
<ul style="list-style-type: none"> ● When transporting the product, pay close attention to its center of gravity and mass. Use an appropriate lifting equipment to lift the unit. Improper lifting may result in the product damage, injury, or death. 	<ul style="list-style-type: none"> ● Install the product properly in accordance with this instruction manual. Improper installation may result in electrical leakage, electrical shock, fire, water leakage, or injury.
<ul style="list-style-type: none"> ● Electrical wiring should be performed in accordance with all applicable regulations in your country. Absolutely provide a dedicated earth leakage circuit breaker and a thermal overload relay suitable for the product (available on the market). Imperfect wiring or improper protective equipment can lead to electrical leakage, fire, or explosion in the worst case. 	<ul style="list-style-type: none"> ● Provide a secure grounding dedicated for the product. Never fail to provide an earth leakage circuit breaker and a thermal overload relay in your starter or control panel (Both available on the market). If an electrical leakage occurs due to a product failure, it may cause electrical shock.
<ul style="list-style-type: none"> ● Use a power outlet that has a sufficient rating and has been exclusively provided for the pump. If the power outlet is shared with other equipment, it can lead to an abnormal heat of the outlet and can cause fire as a result. 	<div style="border: 1px solid black; border-radius: 50%; padding: 5px; display: inline-block;"> Power Supply Capacity </div>



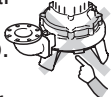





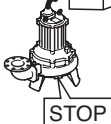

 CAUTION			
	<ul style="list-style-type: none"> ● Be sure to provide a ground wire securely. Do not connect the ground wire to a gas pipe, water pipe, lightning rod, or telephone ground wire. Improper grounding could cause electrical shock. 		<ul style="list-style-type: none"> ● Prevent a metallic object or dust from sticking to the power plug. Adhesion of foreign object to the plug could cause electrical shock, short-circuit, or fire. 
	<ul style="list-style-type: none"> ● Do not scratch, fold, twist, make alterations, or bundle the cable, or use it as a lifting device. The cable may be damaged, which may cause electrical leakage, short-circuit, electrical shock, or fire. 		<ul style="list-style-type: none"> ● Do not use the cable, power plug, or power outlet if it is damaged or it is not closely fitted. Connect every conductor of the cable securely to the terminals. Failure to observe this can lead to electrical shock, short-circuit, or fire. 
	<ul style="list-style-type: none"> ● When the product needs to be carried by hand, decide the number of persons considering the mass of the product. When lifting up the product, do not attempt to do it by simply bowing from the waist. Use the knees, too, to protect your waist. 		<ul style="list-style-type: none"> ● Absolutely install a non-return valve in the discharge piping if the tank is deep or it is long, in order to prevent reverse flow that occurs when the pump stops. Failure to do this may allow the reverse flow, which may result in frequent ON/Off of the pump. This could cause breakdown of the pump and may lead to electrical leakage or electrical shock. 
	<ul style="list-style-type: none"> ● This pump is neither dust-proof nor explosion-proof. Do not use it at a dusty place or at a place where toxic, corrosive or explosive gas is present. Use in such places could cause fire or explosion. 		<ul style="list-style-type: none"> ● If a hose is used for the discharge line, take a measure to prevent the hose from shaking. If the hose shakes, you may be wet or injured. 

PRECAUTIONS DURING TEST OPERATION AND OPERATION

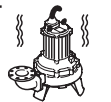

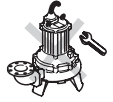

 WARNING			
	<ul style="list-style-type: none"> ● Never try to operate the pump if somebody is present in the pump sump. If an electrical leakage occurs, it can cause electrical shock. 		<ul style="list-style-type: none"> ● Never start the pump while it is suspended, as the unit may jerk and could lead to injury. 
	<ul style="list-style-type: none"> ● When changing power connection is needed to correct the direction of rotation, be sure to turn off the power supply (earth leakage circuit breaker, etc.), and perform the work after making sure that the impeller has stopped completely. Failure to do so may lead to electrical shock, short-circuit, or injury. 		<ul style="list-style-type: none"> ● When inspecting the pump, be sure to turn off the power supply (earth leakage circuit breaker, etc.) so that the pump may not start accidentally. Failure to do so may lead to a serious accident. 
 CAUTION			
	<ul style="list-style-type: none"> ● Do not operate the product under any voltage other than described on the nameplate with the voltage tolerance limit within $\pm 5\%$. If it is operated with a generator, it is strongly suggested not to operate other equipment with the same generator. Failure to observe this caution may cause malfunction and breakdown of the product, which may lead to electrical leakage or electrical shock. 		<ul style="list-style-type: none"> ● Do not touch the product with bare hands during or immediate after the operation, as the product may become very hot during operation. Failure to observe this caution may lead to be burned. 
	<ul style="list-style-type: none"> ● Do not use the product in a liquid other than water. Use in oil, salt water or organic solvents will damage it, which may lead to electrical leakage or electrical shock. 		<ul style="list-style-type: none"> ● Do not run the product dry or operate it with its valve (sluice or gate valve) closed, as doing so will damage the product, which may lead to electrical leakage or electrical shock. 

 CAUTION	
	<p>● Do not use the product for hot or warm liquid over 40°C, as doing so will damage the product, which may lead to electrical leakage or electrical shock.</p> 
	<p>● Do not allow foreign objects (metal objects such as pins or wires) to enter the suction inlet of the pump. Failure to observe this caution could cause it to malfunction or to operate abnormally, which may lead to electrical leakage or electrical shock. Never attempt to insert your finger into the inlet during operation. Doing so can cause injury by the rotation of the impeller.</p>  
	<p>● When the product will not be used for an extended period, be sure to turn off the power supply (earth leakage circuit breaker, etc.). Deterioration of the insulation may lead to electrical leakage, electrical shock, or fire.</p>  



PRECAUTIONS DURING MAINTENANCE AND INSPECTION

 WARNING	
	<p>● Absolutely turn off the power supply or disconnect the plug before starting maintenance or inspection. Do not work with wet hands. Failure to observe these cautions may lead to electrical shock or injury.</p>  
	<p>● In case any abnormality (excessive vibration, unusual noise or odor) is found in the operation, turn the power off immediately and consult with the dealer where it was purchased or Tsurumi representative. Continuing to operate the product under abnormal conditions may result in electrical shock, fire, or water leakage.</p>   
	<p>● Do not disassemble or repair any parts other than those designated in the operation manual. If repairs are necessary in any other than the designated parts, consult with the dealer where it was purchased or Tsurumi representative. Improper repairs can result in electrical leakage, electrical shock, fire, or water leakage.</p> 
 CAUTION	
	<p>● After reassembly, always perform a test operation before resuming use of the product. Improper assembly can result in electrical leakage, electrical shock, fire, or water leakage.</p> 

PRECAUTION TO POWER OUTAGE

 WARNING	
	<p>● In case of power outage, turn off the power supply. The product will resume operation when the power is restored, which presents serious danger to people in the vicinity.</p>  

OTHER PRECAUTION

 CAUTION	
	<p>● Never use the product for potable water. It may present a danger to human health.</p> 

2 PART NAMES

Example

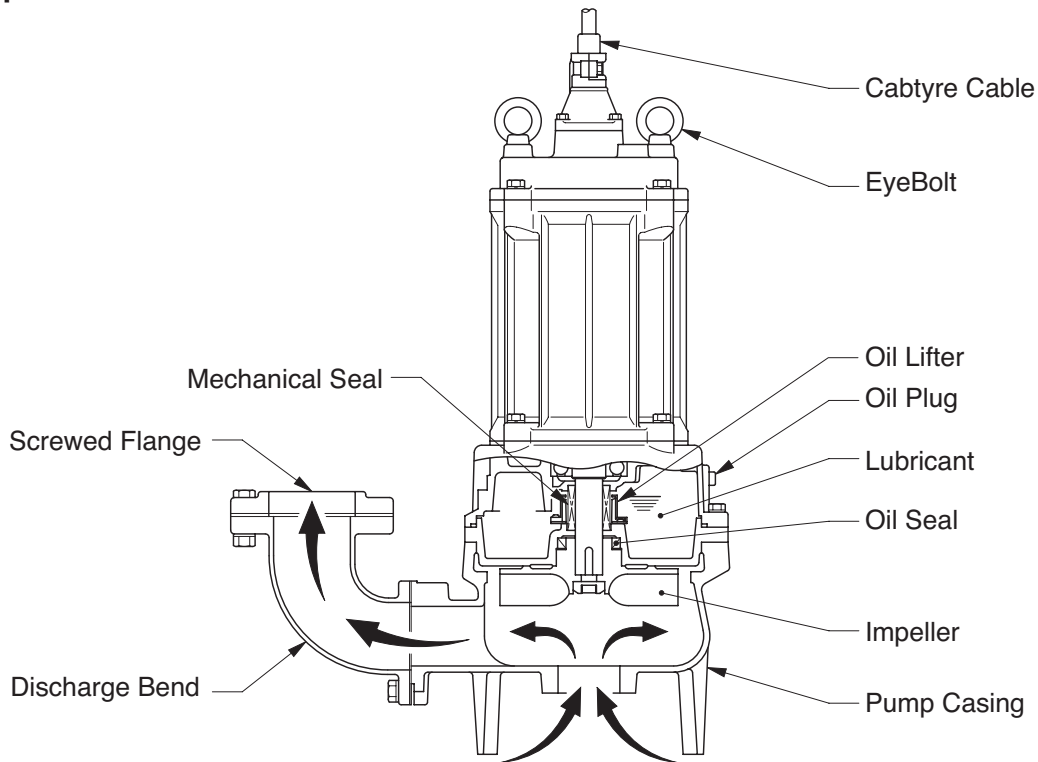

3 PRIOR TO OPERATION

After unpacking, verify the contents.

Product Inspection

Inspect the product for damage during shipment, and make sure all bolts and nuts are tightened properly.

Specification Check

Check the nameplate of the unit to verify that it is the product that you have ordered. Pay particular attention to its voltage and frequency specifications.

Example of nameplate

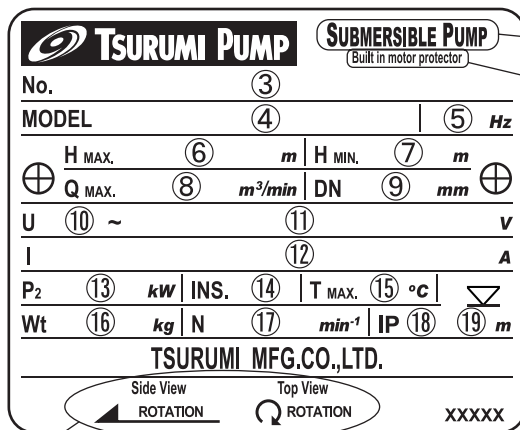

1	Submersible pump	11	Rated voltage
2	Built in motor protector	12	Rated current
3	Serial number	13	Rated output power
4	Model	14	Insulation class
5	Frequency	15	Max. liquid temperature
6	Max. total head	16	Weight without cable
7	Min. total head	17	Speed of rotation
8	Max. flow rate	18	IP degree of protection
9	Discharge bore	19	Max. immersion depth
10	Phase	20	Direction of rotation

Note: If you discover any damage or discrepancy, please contact with the Tsurumi dealer from whom you purchased the product or the nearest Tsurumi representative office.

Accessory Check

Verify that all accessory items are included in the package.

Bend Type

- Discharge Bend (with bolts and packings)1 set
- Screwed Flange (with bolts and packings)1 set
- Operation Manual1

Guide-Rail Type

- Guide Support (with bolts).....1 set
- Duck-Foot Bend (with bolts).....1 set
- Guide Hook (with bolts).....1 set
- Chain for lifting up/down the pump (with shackle).....1 set
- Guide Connector (with bolts).....1 set
- Screwed Flange *11 set
- Operation Manual.....1

*1 : Some of the models are not provided.

Foundation Bolts are not provided.

Note: *If you discover any damage or discrepancy in the product, please contact the dealer where this equipment was purchased or the Tsurumi sales office in your area.*

Product Specifications

CAUTION Do not operate this product under any conditions other than those that have been specified. Failure to observe this precaution can lead to electrical shock, electrical leakage, fire, water leakage or other problems.

Major Standard Specifications

Fluid	Property	Waste water, sewage, and liquid carrying waste and solid matters ; 0 ~ 40°C
Pump	Impeller	Vortex type
	Shaft Seal	Double Mechanical Seal
	Bearing	Shielded Ball Bearing
Motor	Specifications	Dry type Submersible Induction Motor, 4-Pole
	Insulation	Class E, and F
	Protection System (built-in)	Circle thermal protector (7.5kW max.) Miniature protector (11kW, and some models with 5.5kW and 7.5kW)
	Lubricant	Turbine oil VG32 (non-additive)
Discharge Connection		Special screwed flange (only for Bend Type of 1.5kW with discharge ϕ 50mm) JIS 10K flange

4 INSTALLATION

CAUTION

- Do not use the pump for pumping liquids other than water, such as oil, salt water, or organic solvents.
- Use with a power supply voltage tolerance within $\pm 5\%$ of the rated voltage.
- The water temperature for operating the pump should be between 0 ~ 40°C. Failure to observe the precautions given above could cause the pump to malfunction, which may lead to current leakage or electrical shock.

Note: *To use the pump for a special solution, contact the dealer where it was purchased, or the Tsurumi sales office in your area.*

Critical Use Pressure

CAUTION Do not operate the pump in an area that is exposed to a water pressure that exceeds the values given below.

Applicable Pump	Critical Use Pressure
Models with output of 7.5kW or under	0.3MPa(3kgf/cm ²) – discharge pressure during use
Models with output of 11kW	0.4MPa(4kgf/cm ²) – discharge pressure during use

Preparation for Installation

Use a megger to measure the resistance between each core of the cabtyre cable and the (green) ground wire to verify the insulation resistance of the motor.

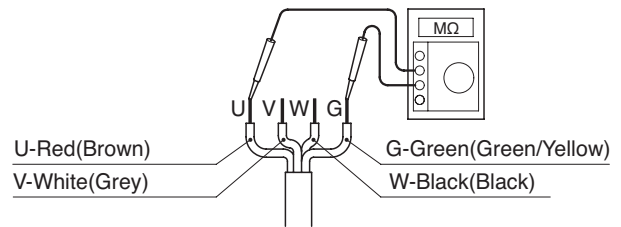

Insulation resistance reference value = 20M Ω minimum

Note: *The insulation resistance reference value of 20M Ω minimum is based on a new or repaired pump. For reference values of a pump that has already been put into operation, refer to "7. Maintenance and Inspection" of this manual.*

Precautions During Installation

WARNING When installing the pump, be mindful of the pump's center of gravity and weight. If the pump is not suspended properly, the pump may fall and break, which may lead to injury.

CAUTION When installing or moving the pump, never suspend the pump by the cabtyre cable. Doing so will damage the cable, which may cause a current leakage, electrical shock, or fire.

Refer to the installation examples illustrated below and pay attention to the points described below to install the pump.

CAUTION During piping work if the welding sparks, paint, or concrete come in contact with the pump, they could cause the pump to malfunction, which may lead to current leakage or electrical shock.

Free Standing Specification

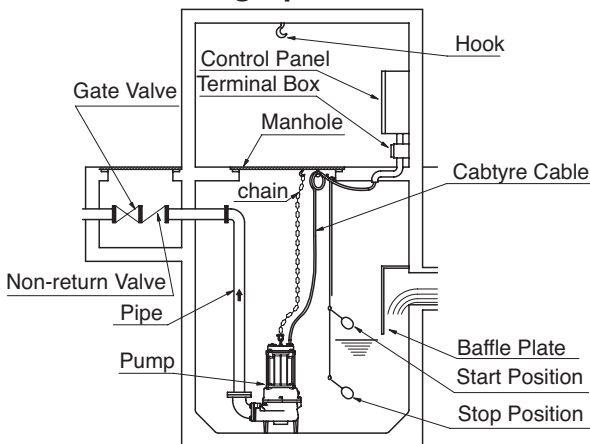

Guide-Rail Specification

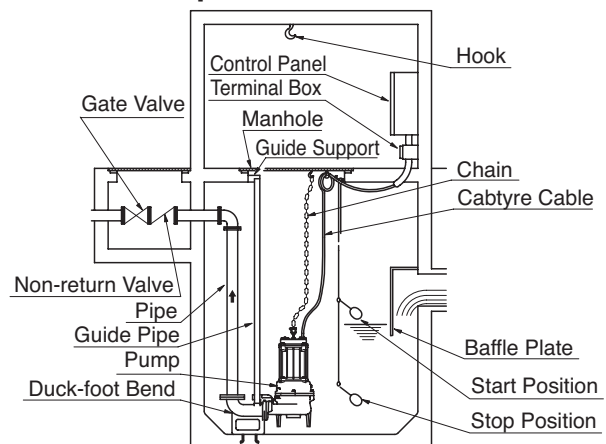

- (1) When transporting or installing the pump, do not kink the cabtyre cable or use it in place of a rope.
- (2) With the cabtyre cable lifted slightly, secure it to the hook (a hook must be prepared in advance by placing it on the frame of a manhole or the like).

CAUTION Do not operate the pump with the cabtyre cable dangling. Failure to observe this precaution may cause the cabtyre cable to become wrapped around the impeller, which could cut the cable, break the impeller, or cause flooding, which may lead to current leakage or electrical shock.

- (3) Install the pump on a horizontal and rigid surface such as concrete, in an area that is free from turbulence and does not cause the pump to take air in.
- (4) The area near the inlet of a water tank is susceptible to turbulence or allows the pump to take air in; therefore, place the pump and the float switch away from the inlet or install a baffle plate.
- (5) Properly perform piping work so as not to create any air pockets in the middle of piping.

CAUTION With automatic control, the sewage water in the pipe could flow backwards, causing the water surface control to react immediately. As a result, the pump will operate ON/OFF repeatedly, which could cause the pump to malfunction.

- (6) Install a non-return valve if the pump tank is deep, or if the vertical head or the lateral distance is long.

Attaching a Chain to Suspend the Pump

Refer to the illustration on the right in order to suspend the pump by a chain.

CAUTION

Make sure that the chain does not become twisted during installation. Failure to observe this precaution could cause the chain to break and the pump to fall and break, which could lead to injury. When you mount shackles, be also careful so that the eye-bolt (pin) may not get dislocated, by means of providing a stainless steel wire or tying band.

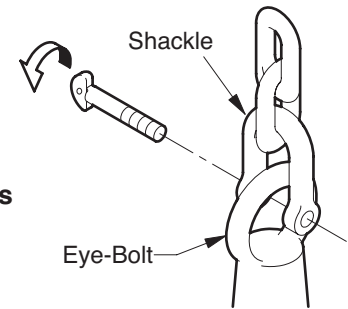

Note: To use the pump with the guide rail, refer to the separate operation manual entitled "Guide Rail".

Installing the Float

The float support is fixed temporarily. Fasten the bolt firmly. Then the float pipe into the float support, and to tighten the Butterfly bolt. Although the float level is preset, follow the procedures given below to change the level.

- (1) Loosen the butterfly bolt and adjust the height at the top and the bottom of the float pipe to set the starting and stopping water levels.
 - (2) After completing the setting, tighten the butterfly bolt to secure both the top and the bottom of the float pipe.
- * In the case of an automatic alternating model, apply the same procedures to set the starting water level. Then, by loosening the screw of pipe holder, set the parallel operation water level as desired. Fasten the screw to secure the support pipe for the parallel operation float.
 - * To prevent unintended operation, face the floats outward.

Adjusting the start float to set the starting water level as desired:

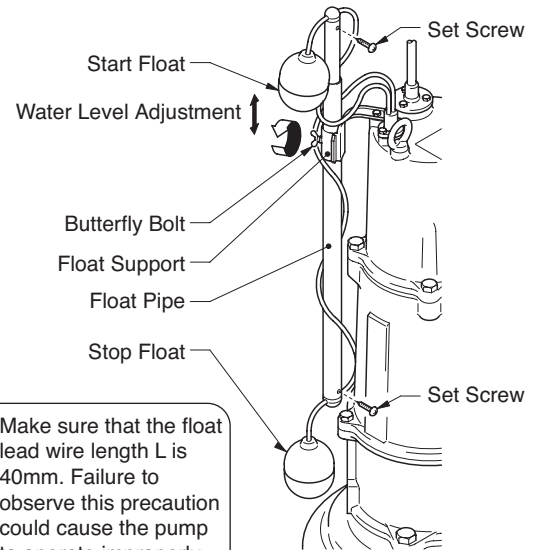

To change the operating water level on an automatic alternating model, perform the setting by referring to the diagram on the right.

- * After changing the water level on an automatic alternating model, make sure to adjust its automatic side.
- * Pay attention to the positional relationship between floats 3, 4, and 5 to perform the settings.

Number	Name	Color
1	No. 1 Pump Stop Float	Red
2	No. 2 Pump Stop Float	Red
3	No. 2 Pump Alternating Start Float	Yellow
4	No. 1 Pump Start Float	Yellow
5	No. 1 Pump / No. 2 Pump Parallel Operation Float	Green

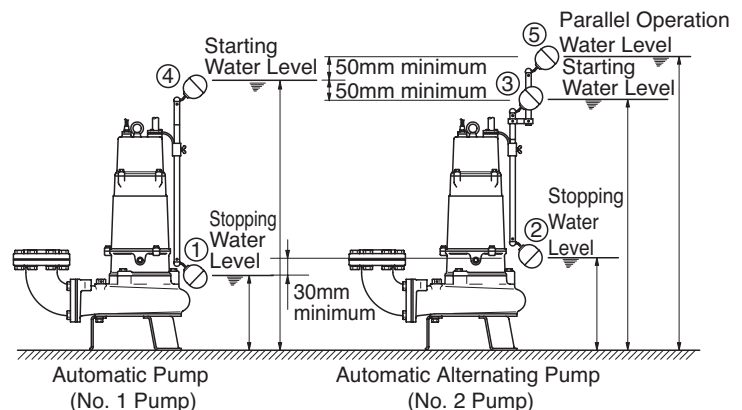

5 ELECTRICAL WIRING

Electrical Wiring Work



WARNING

- All electrical work must be performed by an authorized electrician, in compliance with local electrical equipment standards and internal wiring codes. Never allow an unauthorized person to perform electrical work because it is not only against the law, but it can also be extremely dangerous.
- Improper wiring can lead to current leakage, electrical shock, or fire.
- Absolutely provide a dedicated earth leakage circuit breaker and a thermal overload relay suitable for the pump (available on the market). Failure to follow this warning can cause electrical shock or explosion when the product fails or an electrical leakage occurs.

Operate well within the capacity of the power supply and wiring.

Grounding



WARNING

Be sure to install the ground wire securely. Failure to observe this precaution could damage the pump and cause current leakage, which may lead to electrical shock.



CAUTION

Do not connect the ground wire to a gas pipe, water pipe, lightning rod, or telephone ground wire. Improper grounding could cause electrical shock.

Connecting the Power Plug



WARNING

Before inserting the power plug or connecting the wires to the terminal board, make sure that the power supply (i.e. circuit breaker) is properly disconnected. Failure to do so may lead to electrical shock, short, or injury caused by the unintended starting of the pump.



CAUTION

Do not use damaged cable cables, power plugs, or loose power outlets. Failure to observe this precaution could lead to electrical shock, short circuit, or fire.



CAUTION

Route the control cable (S) away from the power cable as much as possible. Wiring them together will cause the pump to operate improperly.

Follow the diagram on the right to connect the power.

When a three-phase power source is used, connect the leads to the control panel terminals as shown in the diagram, making sure they do not become twisted together.

Direct-on-line

(models with 7.5kW maximum power output)

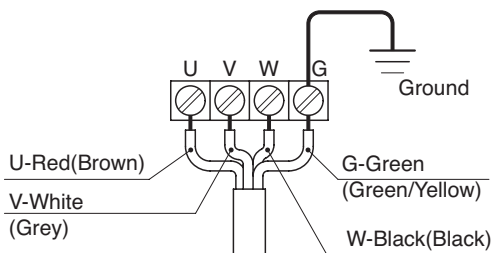

Star-delta start

(some models with 5.5kW and 7.5kW power output)

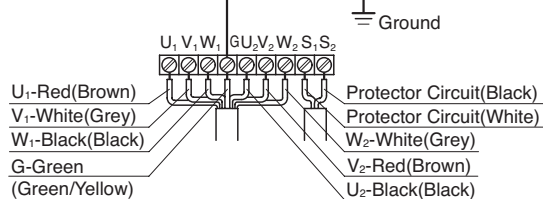

Star-delta start

(models with 11kW power output)

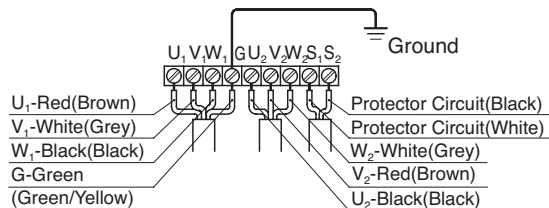

■ SPECIAL NOTE FOR D.O.L STARTING

■ Wiring for Model 11kW (15HP) model

Applicable to the following models :

80UZ411 (11kW or 15HP) ,100UZ411(11kW or 15HP)



WARNING These models can be used as a direct-on-line, (across the line) start pump. To connect for D.O.L. start, please read following instruction carefully.

Example: 11kW (15HP) model

(supplied with two power cables and one motor protector cable)

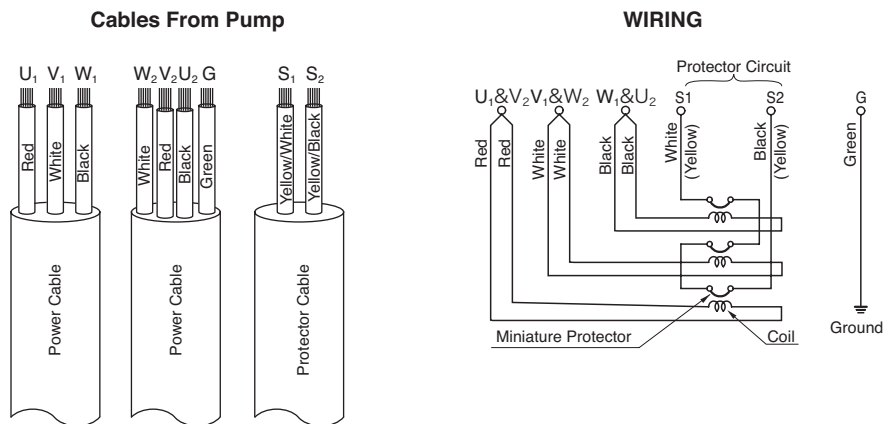

How to connect leads:

Connect lead wires U1 (RED) and V2(RED) to T1 in the control panel.

Connect lead wires V1 (WHITE) and W2(WHITE) to T2 in the control panel.

Connect lead wires W1 (BLACK) and U2(BLACK) to T3 in the control panel.

Connect lead wires S1 and S2 for Miniature Thermal Protector Circuit in Series with the control circuit or control relay.

Note: Failure to connect the Miniature Thermal protection will void the warranty on the unit.



WARNING All electrical work must be performed by an authorized electrician, in compliance with national and local electrical equipment standards and wiring codes. never allow an unauthorized person to perform electrical work because it is not only against the law, but it can be extremely dangerous.

■ Motor Protector

The pump is equipped with an internal motor protector.

1. Circle Thermal Protector:

If a current overload or overheating occurs under the symptoms given below, the motor will stop automatically to protect the motor regardless of the water level at the time of operation.

In this type of motor protector, the motor will automatically restart after cooling down. If the motor is stopped by protector tripping, turn off the power supply first, and disconnect the cables from the power terminals. After this, make sure to eliminate the cause of the problem, such as the following:

- Extreme fluctuation of power supply voltage
- Pump operated under overload condition
- Pump operated at open phase or binding condition



WARNING If repair or maintenance is attempted with cables connected to power supply, unintended automatic restarting of the motor may cause human injury.

2. Miniature Protector

Embedded in the winding of the motor, the miniature protector's bimetal trips if the motor winding overheats for any reason. Upon receiving this signal, the current to the motor can be cut off through the use of an external starting panel or installing a dedicated electrical circuit in the control panel. When the motor's temperature decreases, the bimetal reverts automatically, but the restarting must be effected at the external starting panel or the control panel.

Note: *Tsurumi's miniature protector adopts a "normally closed" contact system in which the circuit opens when the protector trips (the circuit remains closed when normal). Also, make sure to install an external starting panel or a motor breaker or thermal relay in the control panel to protect the motor from overload. The motor can be protected from overload, open phase, or reverse phase condition by installing a 3E relay.*

Note: *Make sure to eliminate the cause of the problem if the motor protector has tripped. Do not operate the pump at unusually low head, or with the impeller clogged with debris. Doing so will not only prevent the pump from attaining its full potential, but may also generate abnormal noise and vibration and damage the pump.*

Electrical Circuit Diagrams

■ Non-Automatic Circuit

Direct-on-line

(models with 7.5kW maximum power output)

Power Supply: Three-Phase

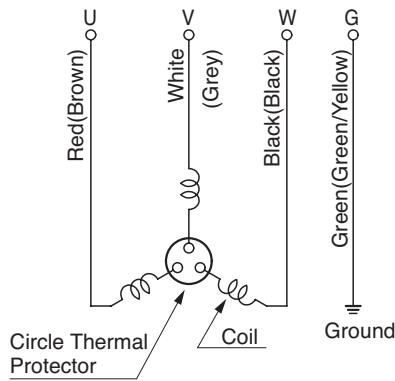

■ Non-Automatic Circuit

Star-delta start

(all models with 11kW power output, and some models with 5.5kW and 7.5kW power output)

Power Supply: Three-Phase

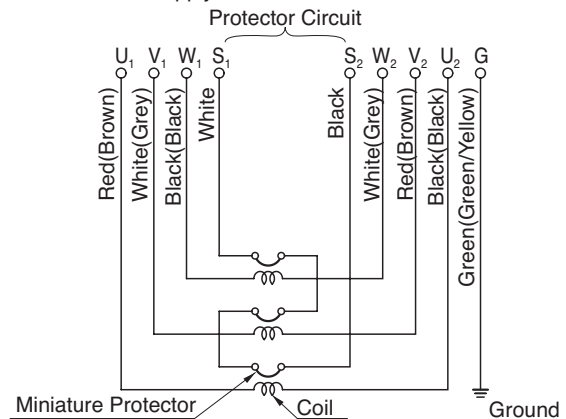

■ Automatic Circuit

(models with 1.5 ~ 3.7kW power output)

Power Supply: Three-Phase

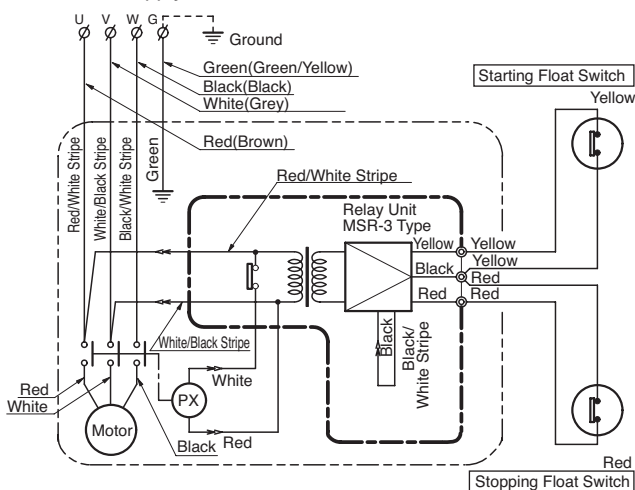

■ Automatic Alternating Circuit

(models with 1.5 ~ 3.7kW power output)

Power Supply: Three-Phase

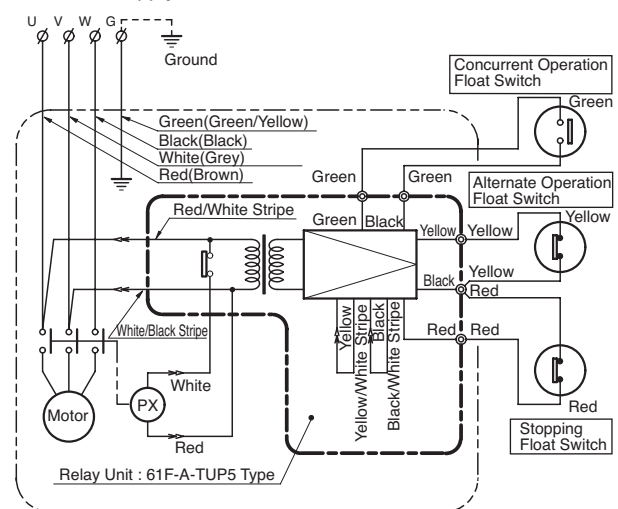

6 OPERATION

Prior to Operation

(1) Once again, check the nameplate of the pump to verify that its voltage and frequency are correct.

CAUTION Improper voltage and frequency of the power supply will prevent the pump from attaining its full potential, and may also damage the pump.

Note: Verify the specs on the pump's nameplate.

(2) Check the wiring, power supply voltage, the capacity of the ground leakage circuit breaker, and the insulation resistance of the motor.

■ Insulation resistance reference value = 20MΩ minimum

Note: The insulation resistance reference value of 20MΩ minimum is based on a new or repaired pump. For reference values of a pump that has already been put into operation, refer to "Maintenance and Inspection".

(3) Adjust the setting of the thermal relay (i.e. 3E relay) to the pump's rated current.

Note: Verify the rated current on the pump's nameplate.

6-1 NON-AUTOMATIC OPERATION

Trial Operation

WARNING Never start the pump while it is suspended, as the pump may jerk and cause a serious accident involving injury.

(1) Operate the pump for a short time (1 to 2 seconds) and verify the direction of the rotation of the impeller. Observe the pump unit from above, and if its recoil is in the counterclockwise direction, the direction of its rotation is correct.

CAUTION Make sure to check the pump's direction of rotation with the pump exposed to the atmosphere. Operating the pump in reverse while it is submerged in water will damage the pump, which may lead to current leakage and electrical shock.

(2) To reverse the rotation, the following countermeasures must be taken.

WARNING Before changing the connections for reverse rotation, make sure that the power supply (i.e. circuit breaker) is properly disconnected and that the impeller has stopped completely. Failure to observe this may lead to electrical shock, short, or injury.

COUNTERMEASURE

Direct-on-line starting

Interchange any two of the three wires designated U, V, and W, respectively.

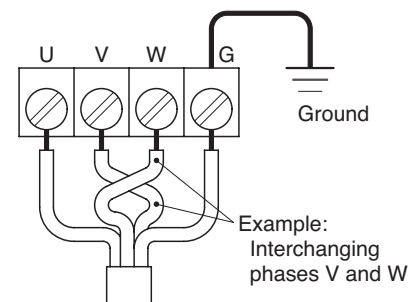

COUNTERMEASURE

Star Delta starting
Interchange any two of the three phases designated R, S, and T, respectively.

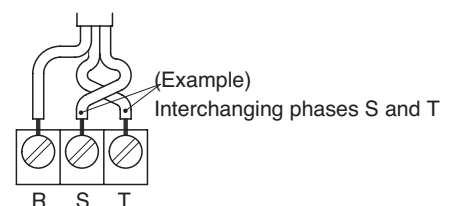

Note: This method cannot be used if the starting panel is equipped with a reverse-phase detector such as a 3E relay. If this is the case, contact the manufacturer of the starting panel, the dealer where the pump was purchased, or the Tsurumi sales office in your area.

(3) Connect the pump to the pipe and submerge it in water.

(4) Operate the pump for a short time (3 to 10 minutes) and perform the following checks:

Using an AC ammeter (clamp), measure the operating current at the phases U, V, and W that are connected to the terminal board.

COUNTERMEASURE

Because an overload condition may be present at the pump motor if the operating current exceeds the rated current, follow the instructions in section "4. Installation" to operate the pump in the correct manner.

Using an AC voltmeter (tester), measure the voltage at the terminal board.

■ Power supply voltage tolerance = within $\pm 5\%$ of the rated voltage

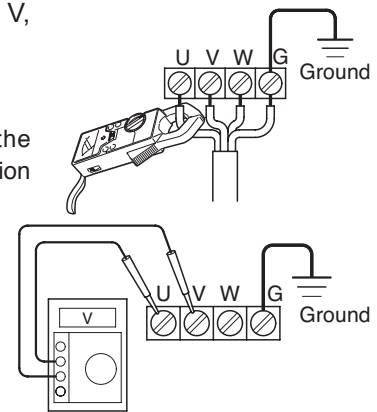

COUNTERMEASURE

If the power supply voltage deviates from the variation value, the cause of the deviation may be the capacity of the power supply or the extension cable that is used. Refer to section "5. Electrical Wiring" to operate the pump in the correct manner.

CAUTION In case the pump exhibits an abnormal condition (such as a considerable amount of vibration, noise, or smell), disconnect the power supply immediately and contact the dealer where you purchased the equipment, or Tsurumi's sales office in your area. If the pump continues to be used in the abnormal state, it may cause current leakage, electrical shock, or fire.

(5) Proceed with the normal operation if no abnormal conditions are found during the trial operation.

Operation

WARNING The pump unit may be extremely hot during operation. To prevent burns, do not touch the pump unit with bare hands during or after the operation.

Pay attention to the water level during the pump operation. The pump will become damaged if it is allowed to operate dry.

Due to an overload operation or a pump malfunction, if the motor protector trips to stop the pump, make sure to eliminate the cause of the problem before restarting.

A frequent ON/OFF will shorten the lifetime of the pump.

To operate a submersible pump (including automatic operation), set the water level so that the pump will operate at approximately the following rate: less than 5-6 times per hour on models with output of 3.7kW or less, and 3-4 times per hour on models with output of 5.5kW or more.

Note: A large amount of amperage flows when a submersible pump is started, causing the temperature of its windings to rise rapidly. Beware that a frequent stop-and-go operation of the pump will accelerate the deterioration of the insulation of the motor windings and thus affect the use life of the motor.

Operating Water Level

CAUTION Do not operate the pump at the lowest water level longer than 30 minutes, as it could damage the pump, causing current leakage and electrical shock. For details on the lowest water level, refer to the dimension drawing, which is provided separately.

6-2 Automatic Operation

Trial Operation

Equipped with floats to detect the water level and an internal control circuit, the automatic type (UZA) pump can perform an automatic drainage operation alone by merely connecting its cable to a power supply. Connect the power and perform a trial operation as follows:

- (1) Direct all the floats downward.
- (2) First raise the (red) stop float, then the (yellow) start float. This will cause the pump to start.
- (3) Next, return the (yellow) start float, and then the (red) stop float to their original positions. This will cause the pump to stop.
- (4) Perform steps (2) and (3) consecutively two or more times to verify the operation.

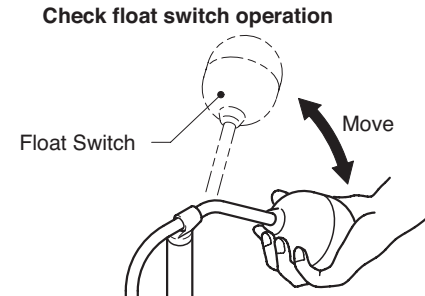

Note: Allow the pump to operate a minimum of 2 seconds for each trial operation. The trial operation must be completed within 1 minute.

CAUTION In case the pump exhibits an abnormal condition (such as a considerable amount of vibration, noise, or smell), disconnect the power supply immediately and contact the dealer where you purchased the equipment, or Tsurumi's sales office in your area. If the pump continues to be used in the abnormal state, it may cause current leakage, electrical shock, or fire.

6-3 Automatic Alternating Operation

Trial Operation

The (UZW) automatic alternating type pump is used in conjunction with the (UZA) automatic type. Equipped with floats to detect the water level and an internal control circuit, it can perform an automatic alternating drainage operation by merely connecting its cable to a power supply. Connect the power and perform a trial operation as follows:

- (1) Direct all the floats downward.
- (2) First raise the (red) stop float, then the (yellow) alternating start float.
- (3) Next, return the (yellow) alternating start float, and then the (red) stop float to their original positions. This will cause the pump to stop.
- (4) Perform steps (2) and (3) consecutively three or more times to verify the operation. The pump will start and stop every other time.
- (5) Again, direct all the floats downward.
- (6) After performing the trial operation of pump by the step (2) and (3). Raise the (red) stop float, then the (yellow) alternating start float, and the (green) parallel operation float. This will cause the pump to start.
- (7) Next, return the (green) parallel operation float, then the (yellow) alternating start float, and then the (red) stop float to their original positions. This will cause the pump to stop.
- (8) Perform steps (6) and (7) consecutively two or more times to verify the operation.

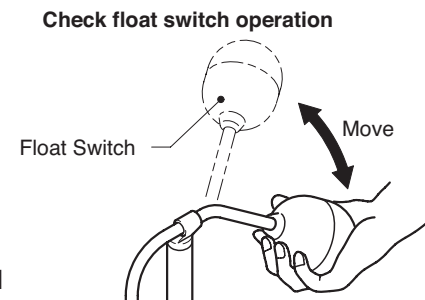

Note: It takes approximately 1 second for the pump to start after the float is moved. Allow the pump to operate a minimum of 2 seconds for each trial operation. The trial operation must be completed within 1 minute.

CAUTION In case the pump exhibits an abnormal condition (such as a considerable amount of vibration, noise, or smell), disconnect the power supply immediately and contact the dealer where you purchased the equipment, or Tsurumi's sales office in your area. If the pump continues to be used in the abnormal state, it may cause current leakage, electrical shock, or fire.

7 MAINTENANCE AND INSPECTION

Regular maintenance and inspection are indispensable to maintaining the pump's performance. If the pump behaves differently from its normal operating condition, refer to section "9. Troubleshooting" and take appropriate measures at an early stage. We also recommend that you have a spare pump on hand for an emergency.

Prior to Inspection

WARNING Make sure that the power supply (i.e. circuit breaker) is disconnected and disconnect the cable from the power outlet or remove it from the terminal board. Failure to do so may cause electrical shock or unintended starting of the pump, which may lead to serious accidents.

- (1) Washing the Pump
Remove any debris attached to the pump's outer surface, and wash the pump with tap water. Pay particular attention to the impeller area, and completely remove any debris from the impeller.
- (2) Inspecting the Pump Exterior
Verify that there is no damage, and that the bolts and nuts have not loosened.

Note: If the pump must be disassembled for repair due to damage or loose bolts or nuts, contact the dealer where it was purchased, or the Tsurumi sales office in your area.

Daily and Periodic Inspection

Interval	Inspection Item
Daily	Measuring the operating current ■ To be within the rated current Measuring the power voltage ■ Power supply voltage tolerance = within $\pm 5\%$ of the rated voltage
Monthly	Measuring the insulation resistance ■ Insulation resistance reference value = 1M Ω minimum [NOTE] The motor must be inspected if the insulation resistance is considerably lower than the last inspection.
Half-yearly	Inspection of lifting chain or rope ■ Replace if damage, corrosion, or wear has occurred to the chain or rope. Remove if foreign object is attaching to it.
Yearly	Inspecting oil ■ 6,000 hours or 12 months, whichever comes first
Once every 2 years	Changing oil ■ 9,000 hours or 24 months, whichever comes first Changing the mechanical seal [NOTE] The inspection and replacement of the mechanical seal requires specialized equipment. To have this operation performed, contact the dealer where this equipment was purchased, or the Tsurumi sales office in your area.
Once every 2 to 5 years	Overhaul ■ The pump must be overhauled even if the pump appears normal during operation. Especially, the pump may need to be overhauled earlier if it is used continuously. [NOTE] To overhaul the pump, contact the dealer where it was purchased, or the Tsurumi sales office in your area.

Note: Refer to section "Oil Inspection and Change Procedures" below for further detail.

Note: In case the pumping liquid contains oil, paint, or slurry, it may cause the swelling of cable jacket or abrasion of the mechanical seal's sealing face, which will result in the pump fault, it is strongly recommended to inspect earlier.

Storage

If the pump will not be operated for a long period of time, pull the pump up, wash the pump, allow it to dry, and store it indoors.

Note: For reinstallation, be sure to perform a trial operation before putting the pump into operation.

If the pump remains immersed in water, operate it on a regular basis (i.e. once a week).

Oil Inspection and Changing Procedures

Inspecting Oil

Remove the oil plug and take out a small amount of oil. The oil can be extracted easily by tilting the pump so that the oil filler plug faces downward. If the oil appears milky or intermixed with water, a likely cause is a defective shaft sealing device (i.e. mechanical seal), which requires that the pump be disassembled and repaired.

Changing Oil

Remove the oil plug and drain the oil completely. Pour a specified volume of oil into the oil filler inlet.

Note: The drained oil must be disposed of properly to prevent it from being released into the sewer or rivers. The packing or the O-ring for the oil plug must be replaced with a new part at each oil inspection and change.

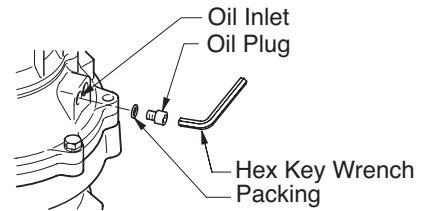

Specified Oil: Turbine Oil VG32 (non-additive)

Unit : ml

Applicable Model	Specified Volume
Model with 0.4 ~ 0.75kW power output	570 ⁽¹⁾
Model with 1.5 ~ 3.7kW power output	1,250
Model with 5.5kW power output	4,200 ⁽²⁾
Model with 7.5kW power output	4,800 ⁽³⁾
Model with 11kW power output	6,400

(1) The specified volume of (TOS) 50UZ4.4/4.75H/4.75L-51/61 will be 530ml.

(2) The specified volume of (TOS) 80/100UZ45.5-54/64 will be 4,300ml.

(3) The specified volume of (TOS) 80/100UZ47.5-54/64 will be 5,200ml.

8 DISASSEMBLY AND REASSEMBLY PROCEDURE

■ Prior to Disassembly and Reassembly



WARNING

Before disassembling and reassembling the pump, be sure that the power supply (i.e. circuit breaker) is disconnected, and remove the cable from the outlet or the terminal board. Do not connect or disconnect the power plug with a wet hand, in order to prevent electrical shock. Do not perform an activation test (to check the rotation of the impeller) during disassembly and reassembly. Failure to observe this precaution could lead to a serious accident, including injury.

This section explains the disassembly and reassembly processes that are involved up to the replacement of the impeller itself. Operations involving the disassembly and reassembly of the sealing portion (i.e. mechanical seal) and of the motor require a specialized facility including vacuum and electrical test equipment. For these operations, contact the dealer where this equipment was purchased, or the Tsurumi sales office in your area.

Disassembly Procedure

Note: Before disassembling, be sure to drain the oil from the pump.

- (1) Removing the pump casing
Remove the hex bolts (four bolts marked "**"), and spring washers; then, remove the pump casing from the pump .
- (2) Removing the impeller
Using a hex key wrench, remove the hex socket bolt and impeller fixing washer; then, remove the impeller and the oil seal from the shaft.

Disassembly Diagram

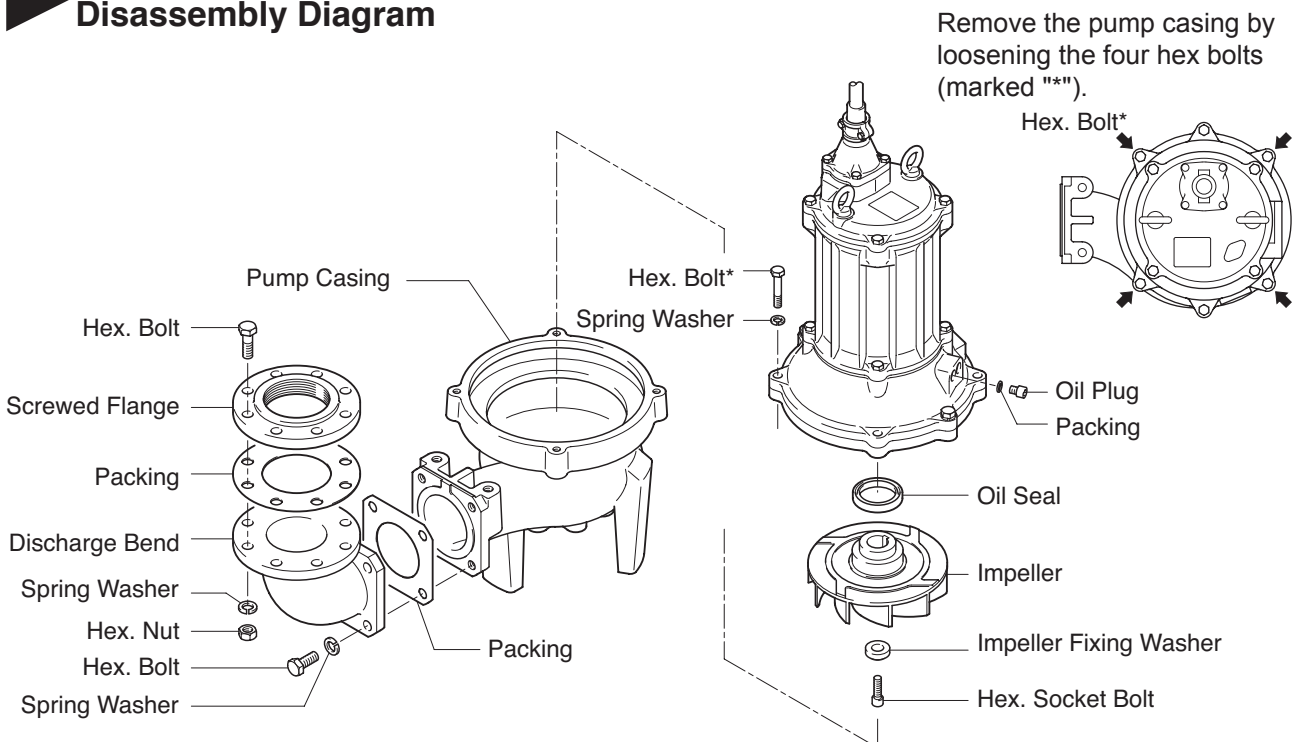

Reassembly Procedure

Observe the precautions given below and reassemble the unit in the reverse order of disassembly.

Note: After completing the reassembly, make sure to fill the pump with the specified amount of oil. The packings must be replaced with a new part. If any part is worn or damaged, make sure to replace it with a new part.

After reinstalling the impeller, check that the impeller rotates smoothly and that there is no interference between it and the pump casing .

9 TROUBLESHOOTING

⚠ WARNING To prevent serious accidents, disconnect the power supply before inspecting the pump.

Read this Operation Manual carefully before requesting repair. After re-inspecting the pump, if it does not operate normally, contact the dealer where this equipment was purchased, or the Tsurumi sales office in your area.

Problem	Possible cause	Countermeasure
Pump fails to start; or, starts but stops immediately.	(1) No proper power is supplied (i.e. power outage). (2) Malfunction in automatic control (control panel) (3) Foreign matter is wedged in the propeller, causing the motor protector to trip. (4) Damaged motor. (5) Open circuit or poor connection of cable. (6) Voltage drop due to the extension of cable. (7) Malfunction in start float.	(1) Contact the electric power company or an electrical repair shop. (2) Have the cause investigated and repaired by a specialist. (3) Inspect the pump and remove the debris. (4) Repair or replace. (5) Replace or properly connect the cable. (6) Shorten the extension cable or replace it with one with a larger size. (7) Remove obstacles and check the operation of the stop float.
Motor protector trips.	(1) Malfunction of motor (seizure or water damage). (2) A 50Hz unit is used at 60Hz. (3) Liquid temperature is too high. (4) Pump has been operating for a long time while being exposed to air. (5) Amperage overload. (6) The movement of the stop float is obstructed, causing the start float alone to perform the start and stop operations.	(1) Repair or replace. (2) Check the nameplate and replace the pump. (3) Lower the liquid temperature. (4) Stop the pump; then lower the water level. (5) Refer to the section on amperage overload. (6) Remove obstacles and check the operation of the stop float.
Pump operates but does not pump water.	(1) An air lock occurred in the pump. (2) The pump or the piping is blocked. (3) The piping is partially blocked or the valve is operating improperly. (4) The motor rotates in reverse.	(1) Stop momentarily and then restart; or, clean the air release valve. (2) Remove the blockage. (3) Remove the blockage, or repair or replace the valve. (4) Change the power supply connection.
Low pumping volume.	(1) The impeller or the pump casing is significantly worn. (2) Excessive piping loss. (3) Operating water level is too low, allowing pump to draw in air. (4) A 60Hz pump is used at 50Hz. (5) There is a leak in the piping. (6) The piping or the pump is clogged with debris.	(1) Repair or replace the affected part. (2) Re-examine the work plan. (3) Raise the water level or lower the pump position. (4) Check the nameplate and replace the pump. (5) Inspect and repair. (6) Remove the debris.
Amperage overload.	(1) Excessive imbalance in the power supply voltage. (2) Excessive voltage drop. (3) Phase interruption. (4) A 50Hz pump is used at 60Hz. (5) Motor rotates in reverse. (6) Pump is clogged with debris. (7) Motor bearing is damaged.	(1) Contact the electric power company or an electrical repair shop. (2) Contact the electric power company or an electrical repair shop. (3) Inspect the connections and the magnetic switch. (4) Check the nameplate and replace the pump. (5) Change the connection of the power wires. (6) Remove the debris. (7) Disassemble the motor and replace the bearing.
The pump does not stop automatically.	(1) The movement of the start and stop floats is obstructed. The switch in a float is faulty. (2) The water level of the stop float is set lower than the pump's minimum possible operating water level.	(1) Remove the blockage. Or, replace the part. (2) Set the water level of the stop float higher than the pump's minimum possible operating water level.
The pumps do not perform proper alternating operation.	(1) The float switch is not set to the proper water level. (2) One of the pumps is malfunctioning.	(1) Set it to the proper water level. (2) Repair or replace the pump.
Not possible to raise the pump (Guide-rail fitting Type)	(1) Mating flange of the duckfoot bend and pump discharge flange went rusty. (2) Guide hook being seized by the guide rails. (3) Cable(s) or Chain get stuck by something.	(1) Shake the chain mildly, and lift the unit slowly. (2) Loosen the chain slightly, and lift slowly while shaking it slightly. (3) Free the point that gets stuck.

The following information is required when ordering repairs or making other inquiries.

Product model	
Manufacturing number	
Purchase date	
Remarks	

Disposal of Product

Properly dispose of the product by disassembling it, presorting the contents, and sending them to the waste material treatment site.